

Article number: 2082276M10B

Description: E+G Mini indexing plunger
without rest position, GN 822.6-6-M10-B

Measures

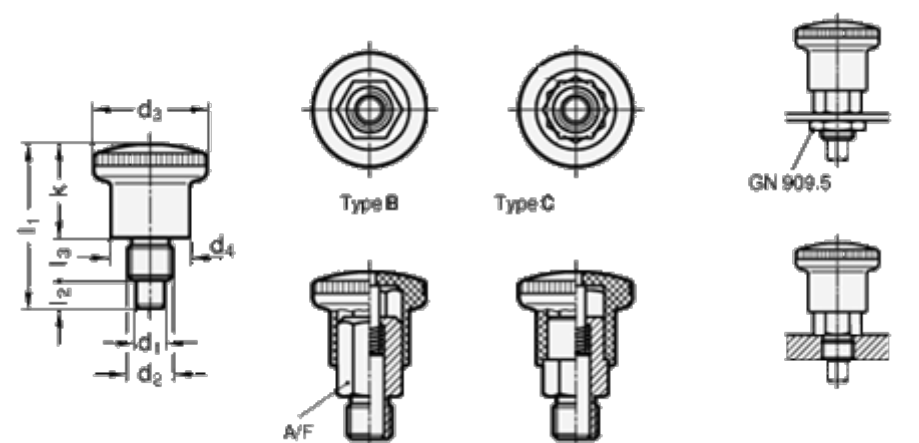

d1 = 6

d2 = M10

d3 = 25

d4 = 18

k = 20.0

l1 = 34.0

l2 = 6

l3 = 8

Spring load initial N = 6